



Modern Building Accessories Factory



Contact

Tel No : +974 40053333

Fax No: +974 40059902

Email Add: info@castle-mba.com

www.castlemba.com

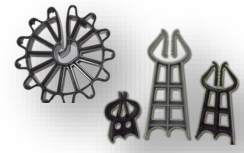

Clip Spacer (MC)

Product Code	Item Description	Concrete Cover (mm)	For Steel Bar Diameter (mm)	Packing Quantity per Bag (pcs)
MBA-MC20	Clip Spacer MC 20	20	4-16	2,000
MBA-MC25	Clip Spacer MC 25	25	4-20	1,000
MBA-MC30	Clip Spacer MC 30	30	4-20	1,000
MBA-MC40	Clip Spacer MC 40	40	4-20	500
MBA-MC50	Clip Spacer MC 50	50	4-20	500
MBA-MC75	Clip Spacer MC 75	75	10-32	250
Application	A medium plastic chair spacer, designed for supporting a minimum load of 100kg according to German performance class L2 (1KN). The clips spacers can be used for various applications in horizontal positions in pre cast or inside concrete. Recommended installation 50cm interval.			



Clampfix Chair Spacer (MCL)

Product Code	Item Description	Concrete Cover (mm)	For Steel Bar Diameter (mm)	Packing Quantity per Bag (pcs)
MBA-MCL20	Clampfix M/D chair spacer20	20	4-16	2,000
MBA-MCL25	Clampfix M/D chair spacer25	25	4-20	1,000
MBA-MCL30	Clampfix M/D chair spacer30	30	4-20	1,000
MBA-MCL40	Clampfix M/D chair spacer40	40	4-20	500
MBA-MCL50	Clampfix M/D chair spacer50	50	4-20	500
MBA-MCL75	Clampfix M/D chair spacer75	75	10-32	250
Application	Clampfix is a sturdy general purpose clip-on spacer used in all types of applications, found in precast yards and on site.			



Normfix Spacer (NF)

Product Code	Item Description	Concrete Cover (mm)	For Steel Bar Diameter (mm)	Packing Quantity Per Bag (pcs)
MBA-NF25	Normfix H/D Spacer 25	25	8-24	500
MBA-NF30	Normfix H/D Spacer 30	30	8-24	500
MBA-NF40	Normfix H/D Spacer 40	40	8-24	500
MBA-NF50	Normfix H/D Spacer 50	50	8-24	250
MBA-NF60	Normfix H/D Spacer 60	60	16-36	200
MBA-NF65	Normfix H/D Spacer 65	65	16-36	200
MBA-NF75	Normfix H/D Spacer 75	75	16-36	150
Application	The wide stands prevent the tipping of the element usage area ranges from radial foundation to heavy duty lying and beams. The durability of our normfix is undeniable.			



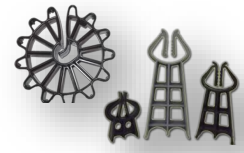

Wheel Spacer (MW)

Product Code	Item Description	Concrete Cover (mm)	For Steel Diameter	Packing Quantity per Bag (pcs)
MBA-MW20	Wheel Spacer MW 20	20	4-13	1,000
MBA-MW25	Wheel Spacer MW 25	25	4-16	1,000
MBA-MW30	Wheel Spacer MW 30	30	4-20	500
MBA-MW40	Wheel Spacer MW 40	40	4-20	250
MBA-MW50	Wheel Spacer MW 50	50	4-22	250
MBA-MW60	Wheel Spacer MW 60	60	8-32	150
MBA-MW65	Wheel Spacer MW 65	65	8-32	150
MBA-MW75	Wheel Spacer MW 75	75	8-32	100
MBA-MW100	Wheel Spacer MW 100	100	8-32	50



Application Wheel Spacer was designed to use in vertical and horizontal reinforcements and it gives the required distance between formwork and rebar.

Modern Universal Spacer (MUS)

Product Code	Item Description	Concrete Cover (mm)	For Steel Diameter	Packing Quantity per Bag (pcs)
MBA-MUS20	Modern Universal Spacer 20	20	4-12	2,000
MBA-MUS25	Modern Universal Spacer 25	25	4-12	1,000
MBA-MUS30	Modern Universal Spacer 30	30	4-12	1,000
MBA-MUS40	Modern Universal Spacer 40	40	6-20	500
MBA-MUS50	Modern Universal Spacer 50	50	6-20	500

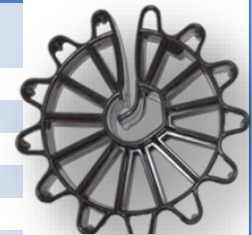

Application Universal wheel spacer is the most extensively used circular spacer for precast and on site concrete applications. Wide contact surface and foot members increase load capacity and prevent tipping.

4 Leg Chair Spacer (4LCS)

Product Code	Item Description	Concrete Cover (mm)	Packing Quantity per Bag (pcs)
MBA-4LCS20	4 Legs Chair Spacer 20	20	500
MBA-4LCS25	4 Legs Chair Spacer 25	25	500
MBA-4LCS30	4 Legs Chair Spacer 30	30	500
MBA-4LCS40	4 Legs Chair Spacer 40	40	500
MBA-4LCS50	4 Legs Chair Spacer 50	50	500



Application The 4 Leg chair spacer is suggested for all kinds of slabs, on site casting, prefabricated, tilt ups, post tension and concrete finish. (comes in various colors)

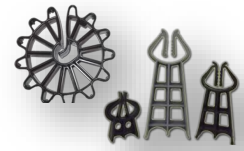

Shimpads (SHP)

Product Code	Item Description	Thickness Sizes mm	Packing Quantity per Bag (pcs)
MBA-SHP7002	Shimpad 70 x 70 x 02	02	1,000
MBA-SHP7003	Shimpad 70 x 70 x 03	03	500
MBA-SHP7005	Shimpad 70 x 70 x 05	05	500
MBA-SHP7010	Shimpad 70 x 70 x 10	10	250
MBA-SHP5002	Shimpad 50 x 50 x 03	03	1,000
MBA-SHP5005	Shimpad 50 x 50 x 05	05	1,000
MBA-SHP5010	Shimpad 50 x 50 x 10	10	500
MBA-USHP7002	U - Shimpad 70 x 70 x 02	02	1,000
MBA-USHP7003	U - Shimpad 70 x 70 x 03	03	1,000
MBA-USHP7005	U - Shimpad 70 x 70 x 05	05	1,000
MBA-USHP7010	U - Shimpad 70 x 70 x 10	10	1,000
Application	Used for alignment and leveling of heavy section steel plate and pre cast concrete sections. Available as plain flat section or horseshoe to fit around connecting bolts.		



Pile Cage Spacers

Product Code	Item Description	Sizes Ø mm	Concrete Cover	For Steel dia	Packing Quantity per Bag (pcs)
MBA-OPS75	Pile Spacer 75mm Open	75	75	12	90
MBA-CPS75	Pile Spacer 75mm Closed	75	75	12	80
MBA-CPS100	Pile Spacer 100mm Closed	100	100	16	50
MBA-CPS125	Pile Spacer 125mm Closed	125	125	16	25

Application Pile cage spacers are attached to the external steelwork of pile cages to ensure correct spacing of the steelwork from the shuttering, and the required concrete cover is maintained over the length of the pile. Pile cage spacers are circular and of high strength to ensure smooth entry of the reinforcing cage without distortion. The pile cage spacers are available as thread-on or clip-on versions, with concrete cover options of 70mm or 45mm.



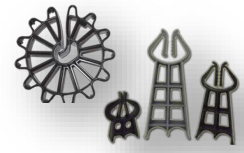

TECHNICAL DATA FOR PLASTIC SPACER CHAIRS AND WHEELS

To achieve the required cover to reinforcing steel according to BS 7973-1-2001, QCS 2010 Section 5 Part 11.5.7 and Part 11.5.8 and ACI SP-66, chairs or wheels must be used according to a standard method of application. The spacers manufactured by MBA are of the plastic "clip on" type, in wheel or chair form. Spacers are available to give cover to a range of bars in nominal steps, typically 20, 25, 30, 40, 60, and 75mm. Plastic Chair Spacers MC are used for spacing of lower reinforcing in slabs and beams and classified under category (L). Plastic Chair Normfix are used for spacing heavy reinforcing steel in slabs and beams and classified under category (H). The MW wheel spacers are for vertical reinforcing steel in walls and columns.

To ensure the correct positioning of the steel, spacers must be placed according to the recommended pattern and the load capacity of the individual chair at the allowable deflection, point load per spacer:

$$MC=0.40 \text{ KN} - \text{Normfix: } 6 \text{ KN} - MW =0.60 \text{ KN}$$

Spacers are marked with type, concrete cover, and bar size range.

CHAIR SPACING FOR SLAB CONSTRUCTION (d = bar diameter)

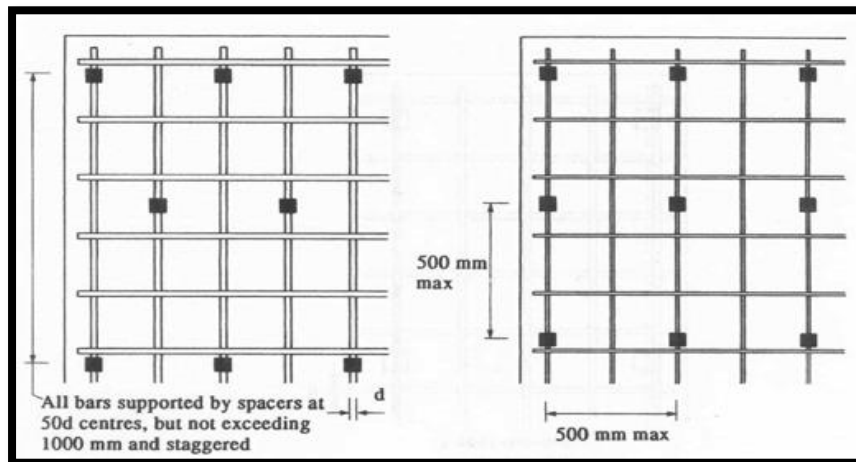

WHEEL SPACING IN COLUMN CONSTRUCTION (d = bar diameter)

Spacers to be fixed vertically to links at top, middle and bottom of each lift, at centers not exceeding 100 x d.

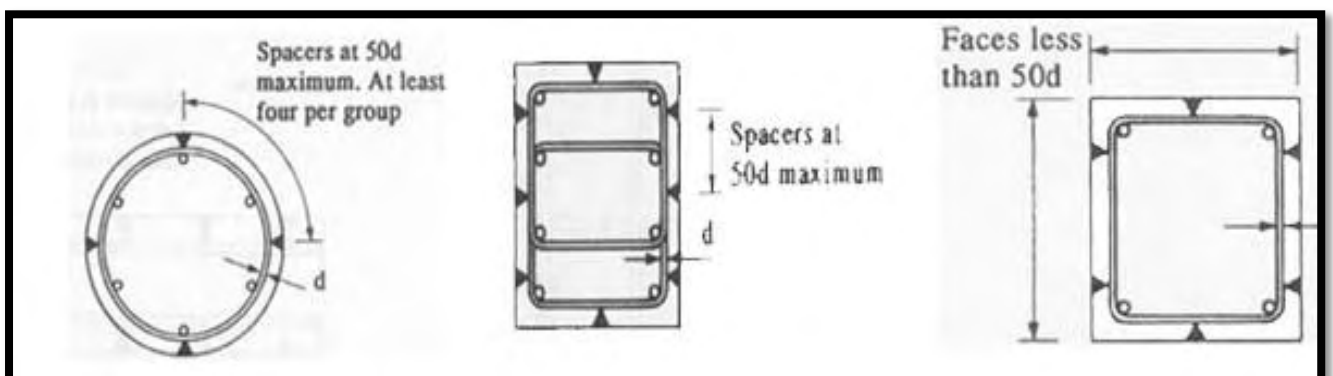



Roof Tile Spacers

Product Code	Item Description	Packing Quantity per Bag (pcs)
MBA-RoofTile	Roof Tile Spacer	200
Application	It provides equal height and joint section at the erection of square ties laid over insulating material at open roofs to protect them against conditions of the nature and with recommended load of 200 kg.	

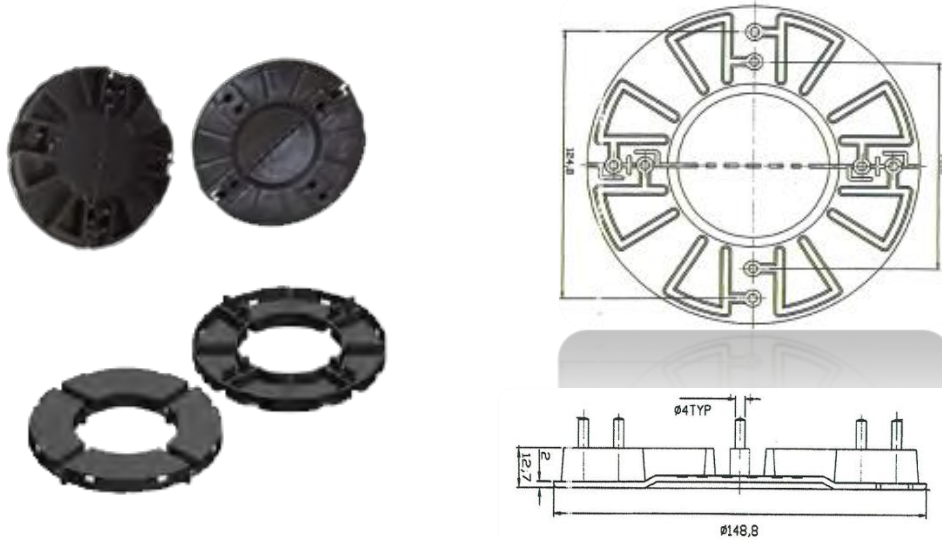

Hollow Core Cap (HCC)

Product Code	Item Description	Slab Height	Packing Quantity per Bag (pcs)
MBA-HCC150	Hollow Core Cap 150	150	500
MBA-HCC200	Hollow Core Cap 200	200	400
MBA-HCC265	Hollow Core Cap 265	265	250
MBA-HCC320	Hollow Core Cap 320	320	150
MBA-HCC400	Hollow Core Cap 400	400	100
MBA-HCC500	Hollow Core Cap 500	500	100
Application	A cap oval or circle in shape used to capped it in both ends of the pre-cast slabs to prevent foreign materials from blocking up the hole opening reverse for installation of conceal service pipes or wires in need. Also prevent concrete from entering the hollow section mean for reduce weight loading on buildings.		





Pipe Spacer (PS)

Product Code	Item Description	Packing Qty. Per Bag (Pcs)
MBA-PS110B	Pipe Spacer 110mm Base	40
MBA-PS110IN	Pipe Spacer 110mm Intermediate	40
MBA-PS160B	Pipe Spacer 160mm Base	40
MBA-PS160IN	Pipe Spacer 160mm Intermediate	40
MBA-PS200B	Pipe Spacer 200mm Base	40
MBA-PS200IN	Pipe Spacer 200mm Intermediate	40
Application	Designed as pipe spacers used to align installed pipes.	

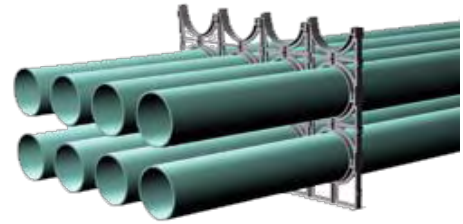
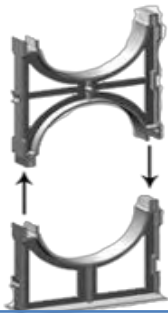

PVC Cone (CONE)

Product Code	Item Description	Color	Sizes ϕ mm	Pipe ϕ mm	Packing Quantity per Bag (pcs)
MBA-CONE22	PVC Cone 22mm	Black	22	25	1,000
MBA-CONE26	PVC Cone 26mm	Black	26	32	1,000
Application	Support cones are used at the end of the PVC tube and can be easily extracted after removal of the formwork				



PVC Sleeves		
Nominal Size (mm)	Inside Diameter	Wall Thickness (mm)
20	17.4	1.4
25	22.1	1.6
32	26.6	2.5
38	33.0	2.5
50	43.2	3.2
Standard Color :	All PVC sleeves are White or Black in color.	
Application	..De bonding sleeves for Tie Rod Pipe ..De bonding sleeves to cover the reinforcement bar at the top of reinforced concrete cast insitu piles.	



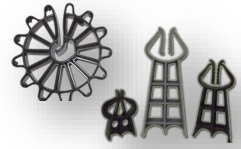

Multi Tubular Pipe Spacer

Technical Specification

- Static Bending Strength is 28 Mpa.
- Modulus of Elasticity is 1,541 Mpa



Material Properties

- Thickness is 12mm, 15mm & 18mm.
- 100 % Water-resistant.
- High Impact Strength.
- Very Smooth Wall Surface Quality.
- Excellent Corrosion, Acid and Alkali Resistance.
- The dimension of board can be customized, length, width, wall thickness and hole diameter as per your design specifications.
- High Temperature resistant, Impact resistant, Low Temperature resistant, abrasion resistant, alkali-resisting, Corrosion resistant, waterproof and fire resistant.

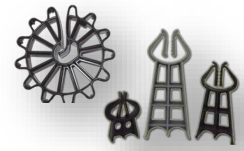

PVC Chamfer

Product Code	Item Description	Size (mm)	Length (m)	Packing Quantity per Bundle (pcs)
MBA-PCF1002	PVC Chamfer 10mm x 10mm x 2m	10	2	100
MBA-PCF1502	PVC Chamfer 15mm x 15mm x 2m	15	2	50
MBA-PCF2002	PVC Chamfer 20mm x 20mm x 2m	20	2	50
MBA-PCF2502	PVC Chamfer 25mm x 25mm x 2m	25	2	50
MBA-PCF3002	PVC Chamfer 30mm x 30mm x 2m	30	2	50

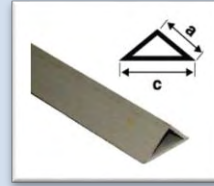
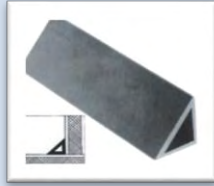

MBA-CFN1002	CFN 10mm x 2m	10	2	50
MBA-CFN2002	CFN 20mm x 2m	20	2	50

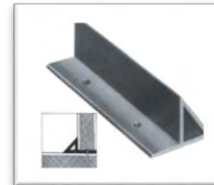
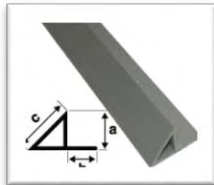

Application Impact resistance PVC figuration for chamfering corners for beams and it prevent s the leaking out of the mould. CFN is nailed in the corners by flange and can be remove afterwards.

MBA Crack Inducer

MBA PVC profile to induce a controlled crack for the use in expansion joints of concrete slabs.

Reference	Height	Length	Packing Qty.
MBAC1 40	40mm	400cm	50m

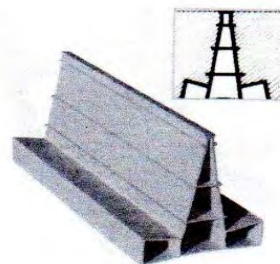

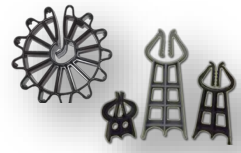

PVC Ceramic Tile Trim

Quick Details

- **Type:** Tile Accessories
- **Place of Origin:** Modern Building Accessories Factory **MBA** (Qatar)
- **Model Number :** 8mm-9mm-10mm
- **Tile Accessory Type :** Tile Trims
- **Material:** PVC
- **Usage:** External Wall



Specifications:

- The PVC tile trim material rigid PVC.
- **Color:** According to the customer requirement.
- We could produce every size you like (8mm/9mm/10mm)
- This PROFILE replaces the traditional mitred joints systems, not used anymore. Against the weakness and breakage of the wall tile corners; these tile trims allow you to protect and enhance external tile corners and edges
- The above PVC Profiles can be used for all kind of tile corners, kitchen, bathrooms etc. Tops finishes and endings, getting always a perfect finish.
- This is the easiest way to protect, to decorate and to reduce high cost of old systems.
- **Length:** Generally 2.5mtr. or according to your requirement

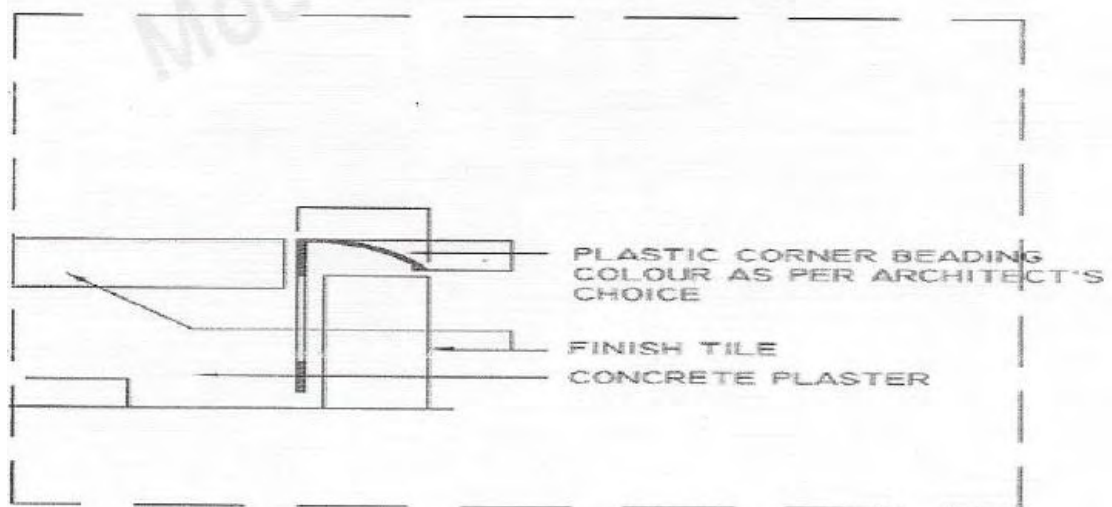



Rebar Protection Cap (RBC)

Product Code	Item Description	Color	Sizes Ø mm	Packing Quantity per Bag (pcs)
MBA-RPC0816	Rebar Protection Cap Yellow 8-16	Yellow	8-16	250
MBA-RPC1632	Rebar Protection Cap Yellow 16-32	Yellow	16-32	250
Application	Act as a safety protection cap for the steel bar ends. Made of plastic which is durable and highly visible to prevent injuries from protruding rebars. Rebar protection cap are just one item in the market today that fit directly with OSHA.			

Note: We can produce any color as per your requirement.



Rebar Protection Cap (EC Type)

Product Code	Item Description	Color	Sizes Ø mm	Packing Quantity per Bag (pcs)
MBA-EC08-16	Rebar Protection Cap EC8-16	Yellow	8-16	500
MBA-EC16-32	Rebar Protection Cap EC16-30	Yellow	16-32	250
MBA-EC25-40	Rebar Protection Cap EC25-40	Yellow	25-40	100
Application	Act as a safety protection cap for the steel bar ends. Made of plastic which is durable and highly visible to prevent injuries from protruding rebars. Rebar protection cap are just one item in the market today that fit directly with OSHA.			

Note: We can produce any color as per your requirement.



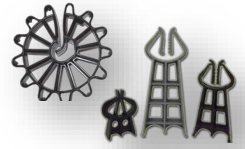

POLYMIDE SLEEVES

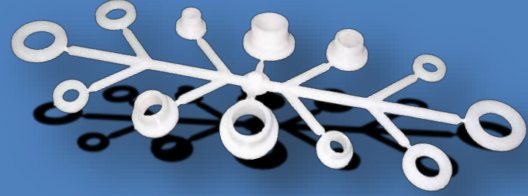

Product Code	Item Description	Color	Sizes Ø mm	Packing Quantity per Bag (pcs)
MBA-PS06	Polymide Sleeve 06	White	06	10,000
MBA-PS08	Polymide Sleeve 08	White	08	10,000
MBA-PS12	Polymide Sleeve 12	White	12	10,000
MBA-PS16	Polymide Sleeve 16	White	16	10,000
MBA-PW08	Polymide Washer 08	White	08	10,000
MBA-PW12	Polymide Washer 12	White	12	10,000
MBA-PW16	Polymide Washer 16	White	16	\10,000

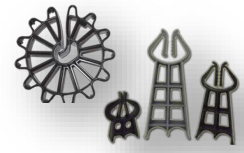

Concrete Movement Joints Accessories

Dowel Bar Sleeves

To provide an efficient method of de-bonding the steel dowel bars.

Dowel Bar End Caps

A quick applied cap supplied with compressible filler. It is designed to allow movement during expansion when fitted to de-bonding sleeves.

Application

Contraction and expansion joints in concrete floors in conjunction with designed dowel bars.

Material Specification

The de-bonding sleeve is made of PVC compound in black color extruded and cut accurate designed lengths. Expansion caps are made high density polyethylene with compressible filler made from low density polyethylene. The sizes are shown below:

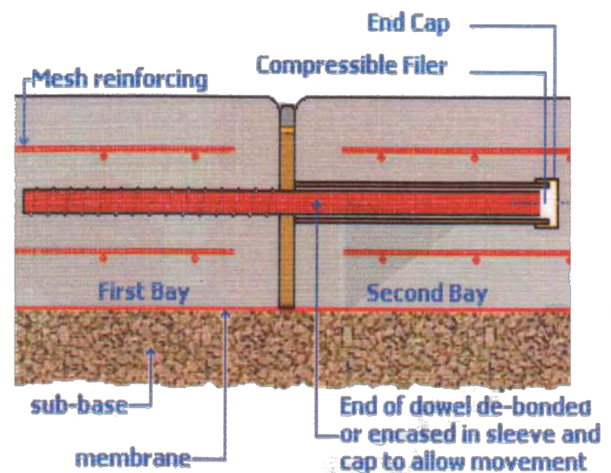

Sleeve Outside Dia (mm)	Dowel Bar Dia (mm)	Sleeve Part No.	Dowel Bar Dia (mm)
20	16	RCM 20	16
25	20	RCM 25	20
32	25	RCM 32	25
40	32	RCM 40	32
50	40	RCM 50	35~40

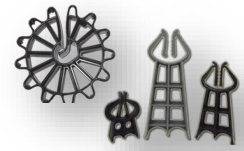

MBA Monolithic Paving System

The product is designed to:

- Create a monolithic paving surface providing high wind uplift resistance
- Carry the lead load of paver surface.
- Perfect final leveling from 22mm to 30mm.

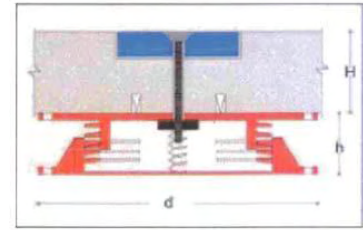

To meet the above targets, MBA monolithic paving system is consisting of:

1. High density polyethylene top plate 70x70x10mm with a middle hole 9mm.
2. Jack support with inside threading allows movements in height to the nearest millimeter.
3. Countersunk bolt M08 with different lengths according to paver thickness.
4. Galvanized spring nut M08.

Specifications and dimensions

DIMENSIONS			
Item Description	Size	Color	Packing
Top Plate	70mm x 70mm x 10mm	Black, other colors possible	250 / bag
Support Jack	d=150mm & h=(22-30)mm	Black	20 / carton
Countersunk Bolt	M08 XL	Black mill finish, S steel bright finish	Varies
G.I. Spring Nut	M08	Silver	50 / carton

Materials

- Top plate and support jack material certificate is shown below
- Countersunk bolt is mill fish, mild steel. S. steel A4 bolt is supplied on request
- Spring nut is zinc plated mild steel.



Raw Material: High Density Polyethylene HDPE B 5429A

Physical Properties	Value	Unit	Test Method
Material Density	0.954	g/cm	ASTM D-1505
Stress Crack Resistance F50 (100% 1 gpal, 50c)	55	Hrs	ASTM D-1693 B
Tensile Strength @ Yield	27(3920)	Mpa (psi)	ASTM D-638
Tensile Strength @ Break	32(4640)	Mpa (psi)	ASTM D-638
Tensile Elongation @ Break	850	%	ASTM D-638
Flexural Modulus	1,200,00		ASTM D-

*UV stabilizer is added to the above.

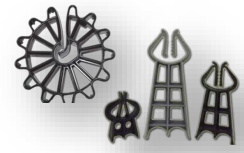

PVC CENTRALIZERS

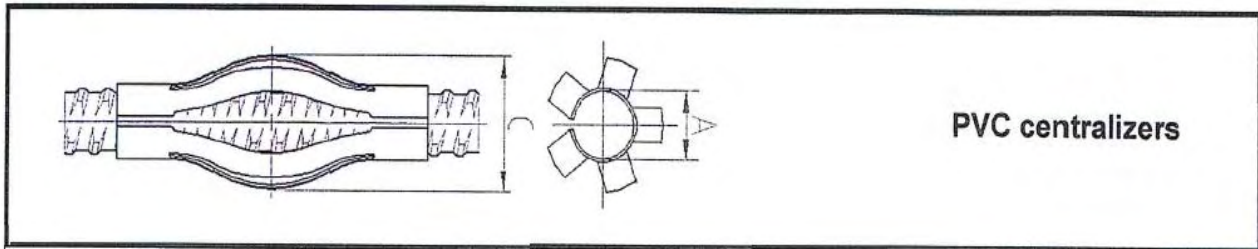

Dimensions

Code	Bar Diameter "A" in mm	External Measurement Diameter "C" in mm
MBC-20	20	70
MBC-25	25	90
MBC-32	32	140
MBC-40	40	150
MBC-50	50	160
MBC-75	75	175

Materials Used

Material:	UPVC According to DIN 8062
Density:	about 1,42 g/cm ³
Yield Point:	> 52 Mpa
Yield Point Elongation:	> 52 Mpa
Elastic Module:	> 3300 Mpa
Vicat HDT:	> 88 °C
Linear Thermal Expansion:	Circa 0.06 mm/m°C
Color Gray, Orange & Black	

